

Specifications



Model: AP-003M

Single channel Panel controller

● Outline

TQ-003M is a new generation of intelligent controller developed by our company used the latest technology of capacitive touch and wireless. Novel and decent color touch panel make it direct and convenient in use. It has stable and reliable performance. Controlling light color of long distance by gentle touch or remote is becoming our routine.

● Features



1. Full touch panel avoiding mechanical wear has longer working life than those with physical buttons.
2. Color touch circle make it direct and convenient in use.
3. Input power adapt to DC12~24V automatically.
4. Input Polarity Protection.
5. Color changing is more exquisite with PWM
6. Using high power original dimming control MOS tube, it is up to 18A drive Load capacity, has stable and reliable performance.
7. With novel and decent appearance , it particular suited to interior home and business places

● Specifications

Controller	
Operating voltage	12V~24VDC
Operating current	8Ax1CH
Output channel	1CH
Output power	96W/192W (12V/24V)
Output control	PWM
Output gray-scale	256
Button number	2buttons , 1 touch circle
Operating temperature	-20°C~60°C
Certification	CE 、 RoHS
GW	130g
Package size	L150*W96*H60mm
Color change mode	10

● Panel Instruction

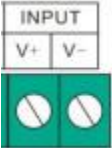
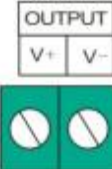

Signal	Function
	Turn On/Off
	Power input port: DC 12~24V
	Load output port: Used to connect LED RGB lamps and lanterns.
	Mode key
	Brightness adjuster

● Mode Table (Customized)

No.	Mode	No.	Mode
1	10% Brightness	6	60% Brightness
2	20% Brightness	7	70% Brightness
3	30% Brightness	8	80% Brightness
4	40% Brightness	9	90% Brightness
5	50% Brightness	10	100% Brightness

● Typical Application

Take RGB strip as an example:

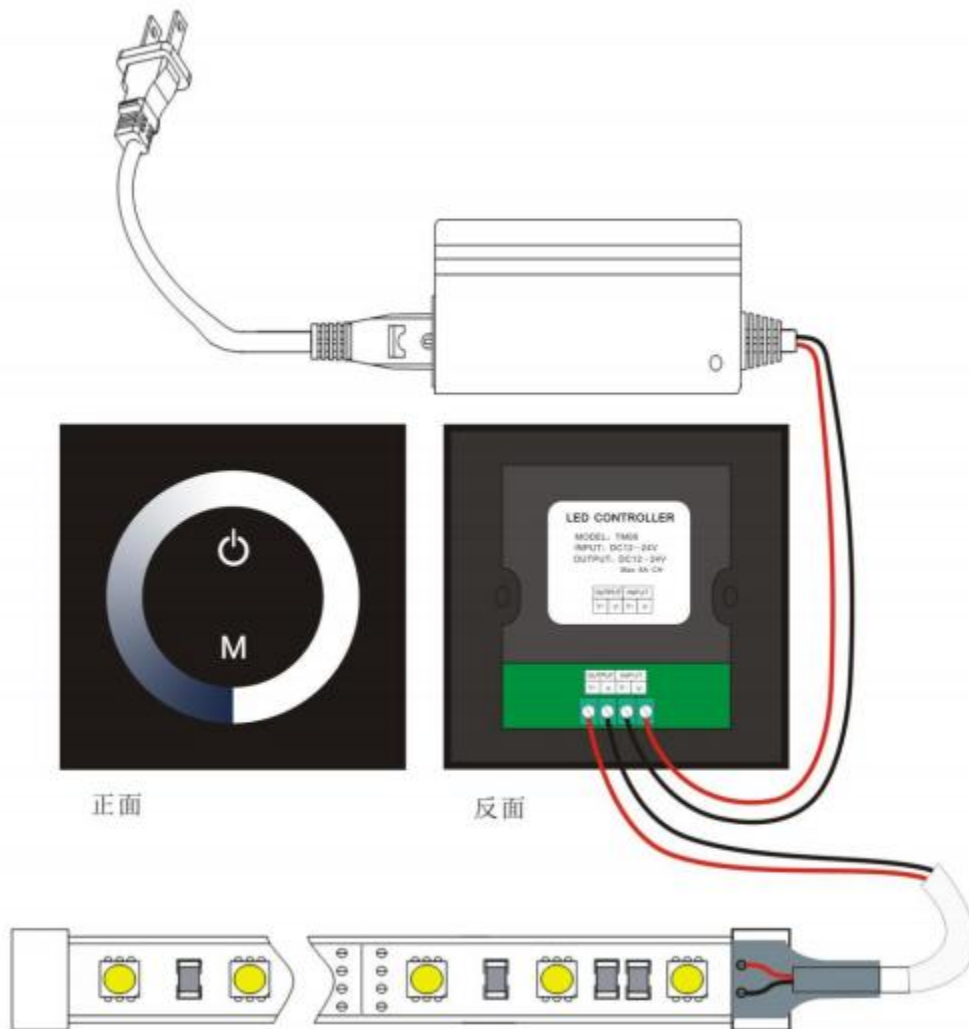

● Power Development Application

Take RGB LED strip as an example and amplifiers are connected to controller's output lines in parallel.

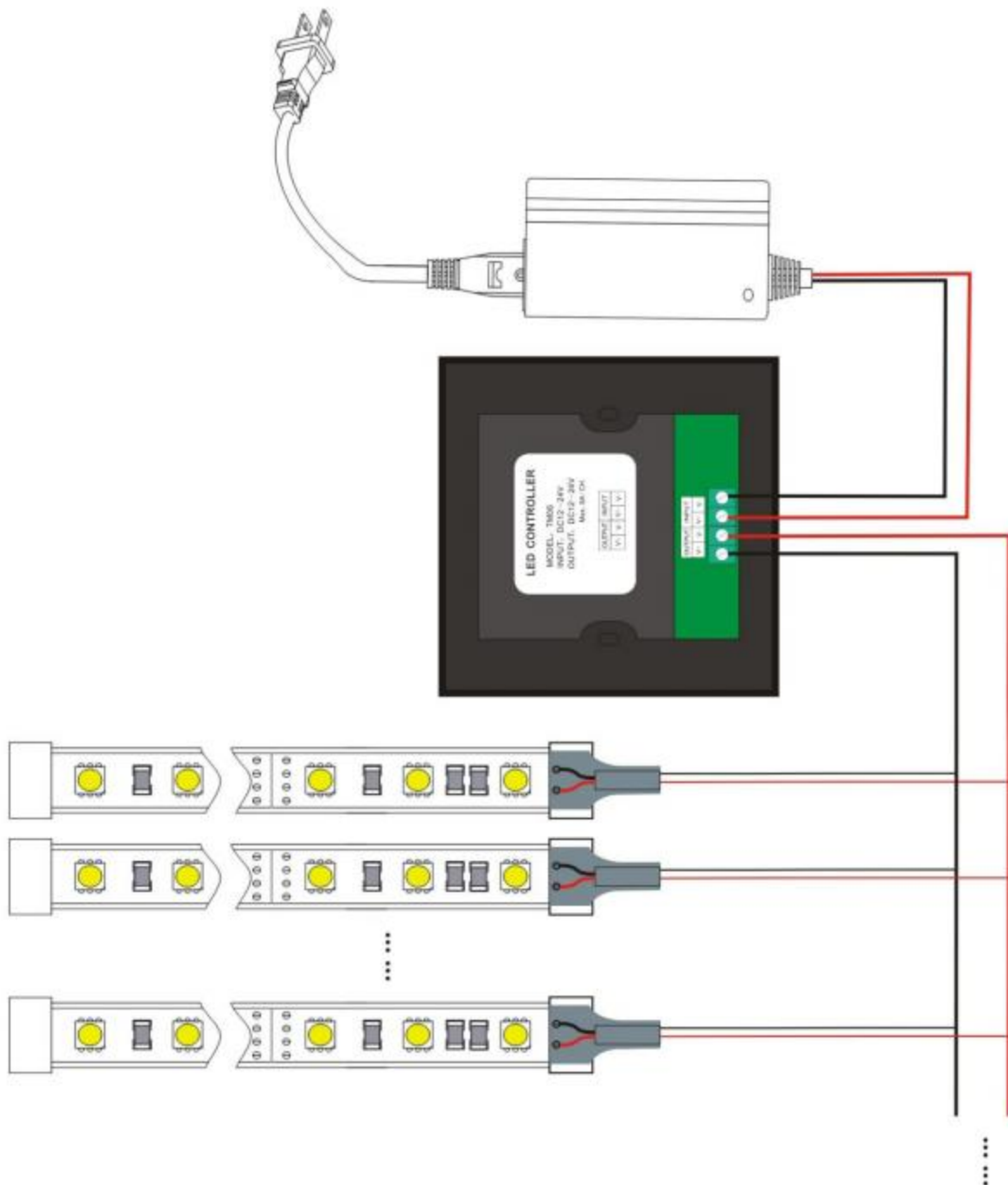

● Dimensions

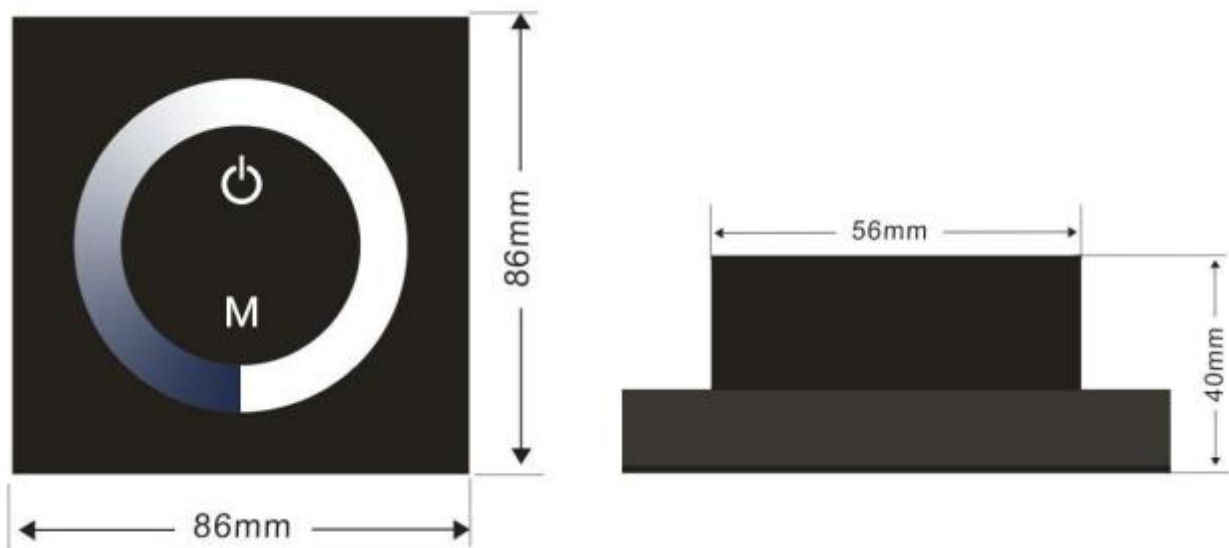

● Packing Details



controller	package	weight	carton	weight/box (50pecs)
L86*W86*H40mm	L110*W110*H55mm	130g	L500×W320×H320mm	6.5kg

● Products Parts

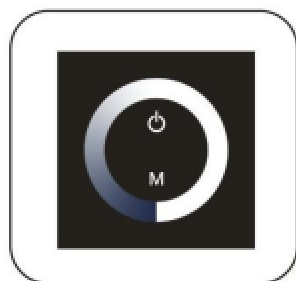

Controller

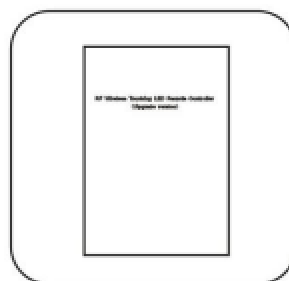

User manual

● Caution

1. Please install the products by Authorized Electrician.
2. This product is non-waterproof, please avoid the sun and rain. If you install it outdoor, please use the waterproof box.
3. Well heat dissipation will extend the product life time. Proper ventilation for the LED Driver is recommend.
4. Please do NOT operate the product while lightening. Do NOT install it in intense magnetic field or near the High Voltage Source.
5. Before using, Please make sure the Controller output Voltage meet the LED Requirement.
6. For safety, be sure that the operating current does NOT overload the wire capability.
7. Before power on, make sure the ports are connected properly, Wrong connection will damage the products.

● Service

We full stand behind our products, provides the technical support and repair for them through their lifetime. Please feel free to contract us if you have any question.

15 Days Warranty

Refund will be made if our products have any problems in 15 days from the date you received the package. Refund will be given if item is returned in its original condition.. On receiving the item, we will refund immediately. For non-defect Item buyer require to pay for the two way shipping freight.

30 Days Warranty

If the item is defective within 30 days, we will supply you a replacement free of charge or a full refund. Buyers require to send back the item and are responsible for return shipping cost with proper packaging. On receiving the item, we will refund or send out a new one(we will pay for the resend postage) immediately.

1 year Warranty

We will replace items which are malfunctioning items for 1 year from the date you receive them . Buyer required to return the original item at his own cost. Buyer need to pay the two way shipping freight

Out-of-warranty Service

ETOUCH-LED will continue to service its products, even after the standard warranty expires. In the event that a product fails outside of the warranty period, the materials cost will be required for repair Circle Products which are on the following terms and conditions are out of free warranty:

Products damaged by man-made damage like over load, improper operation, High voltage and so on.

Products (non waterproof products) soaked in water or been repaired without permission

Products have serious appearance damage or serious deformation caused by transportation or percussion.

Products damaged by Natural disasters and irresistible reason, such as earthquake, flood, fire, etc.